

REV.	REVISIONS REC.	DATE
A/1	① 6.80改到7.30	2014.03.05
	⑲ 1.20改到1.70	2014.03.05

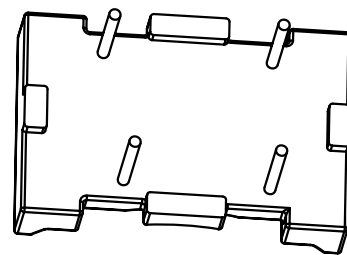
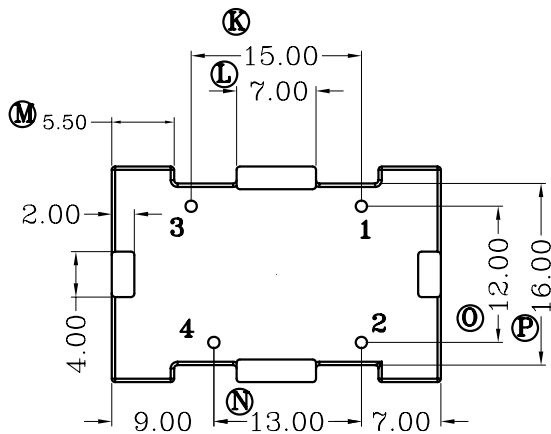
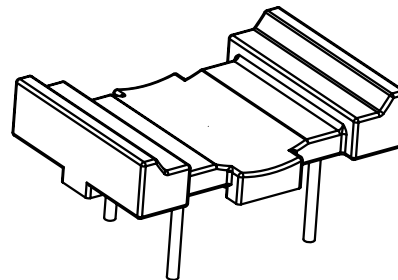
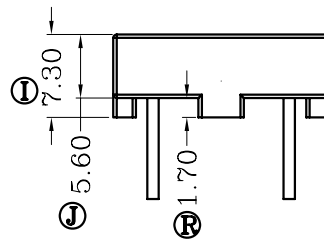
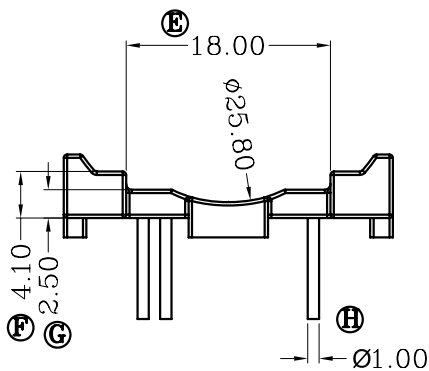
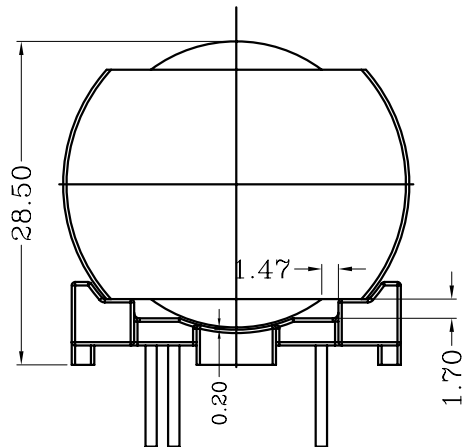
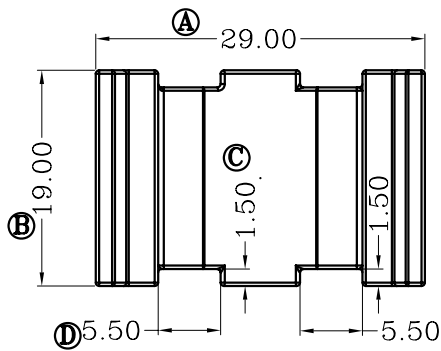

深圳市搏思康电子有限公司
SHENZHEN BOSCOM ELECTRONICS CO.,LTD

型号 MODEL NAME		产品编号 DRAWING NO	
POT-30底座(2+2P)		B-3024	
MATERIAL	PM-9820	PIN MATERIAL	CP WIRE
SCALE	FIT	TOLERANCE	
DRWING	SUM 11/04/13	0<L≤4 ±0.10	
DESIGNED		4<L≤16 ±0.20 壁厚: ±0.10	
APPROVED		16以上 ±0.30 PIN径: ±0.05	

ADDRESS	深圳市观澜街道石马径社区君新路石三工业区146号
TELEPHONE	0755-28032969 28032970 28032971
FAX	0755-28032965