

版本 A/0

REV.	REVISIONS	REC.	DATE

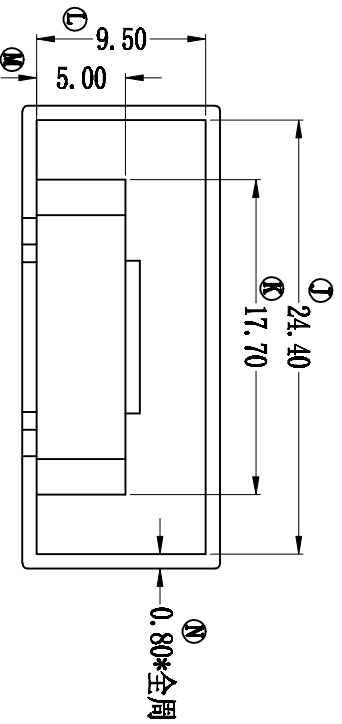
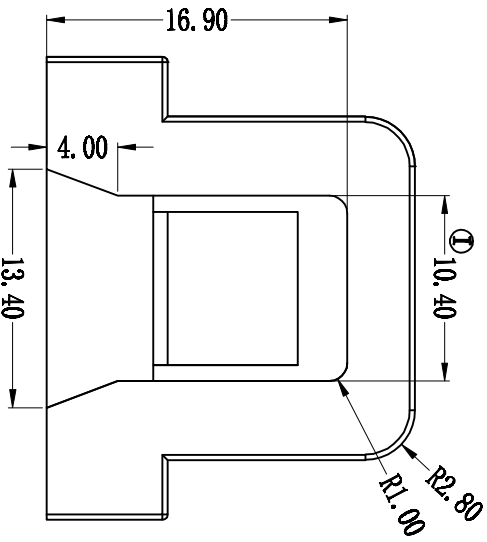
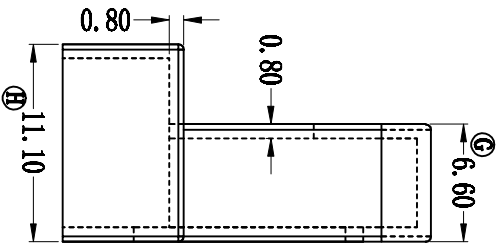
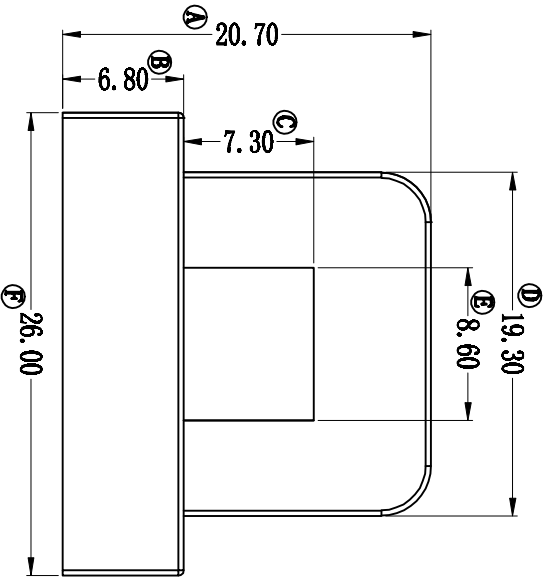
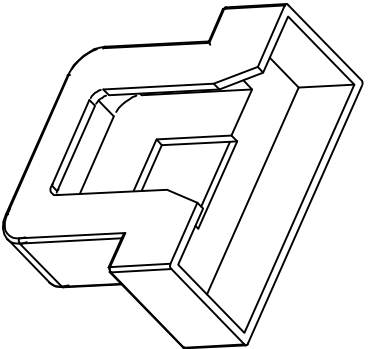
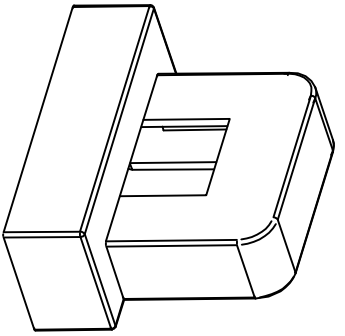
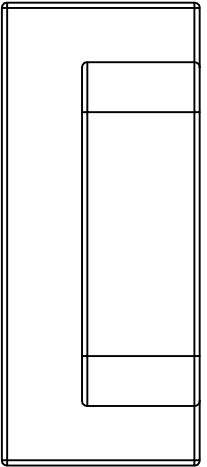

<b>深圳市特思康电子有限公司</b> SHENZHEN WOTEK ELECTRONICS CO., LTD.		<b>型号</b> MODEL NAME <b>E1-28 CASE</b>		<b>产品编号</b> DRAWING NO <b>B-2891-1</b>	
		<b>地址</b> ADDRESS 深圳市观澜街道石马径社区碧新路 石三工业区146号		<b>材料</b> MATERIAL FR-530 米黄 <b>CP 公差</b> TOLERANCES 符合UL94V-0标准	
<b>电话</b> TELEPHONE 0755-28032969 28032970 28032971		<b>SCALE</b> FIT 1:1		<b>尺寸</b> DIMENSIONS ±0.10 量具 ±0.08 ±0.20 塞规 ±0.02 ±0.30 样板 ±0.02	
<b>传真</b> FAX 0755-28032965		<b>DESIGNED</b> 庄永委		<b>DATE</b> 24/08/2018	
<b>APPROVED</b>		<b>APPROVED</b>		<b>APPROVED</b>	