

版本

A/0

REV

REVISIONS REC

DATE

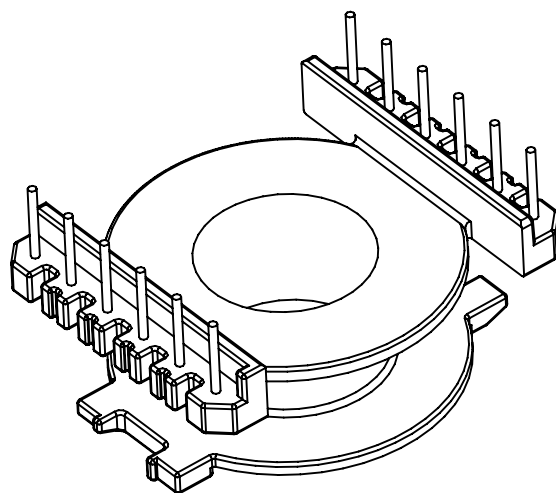
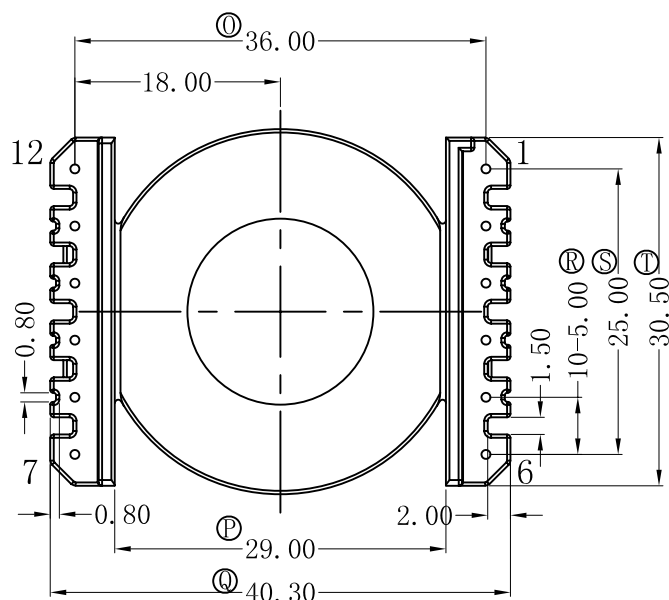
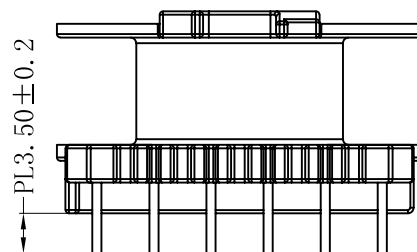
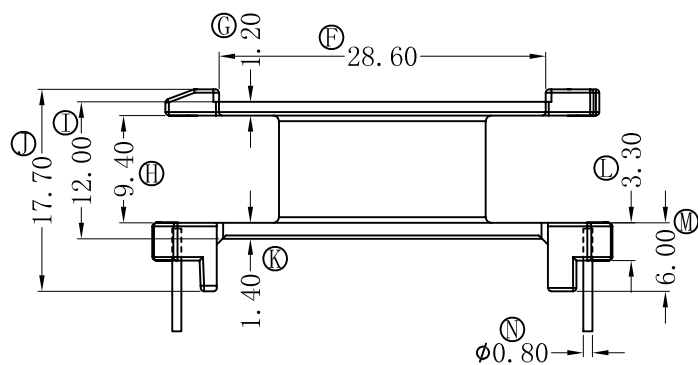
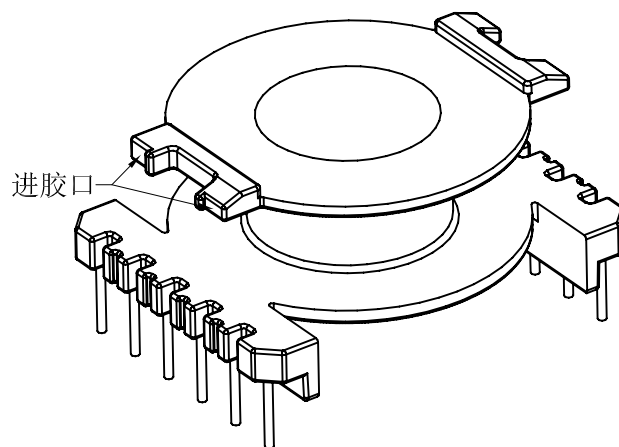
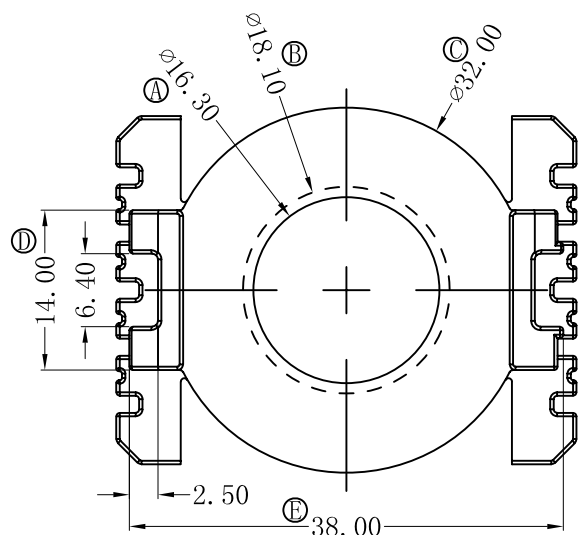

深圳市搏思康电子有限公司

SHENZHEN BOSCOM ELECTRONICS CO., LTD

ADDRESS: 深圳市龙华区观澜街道牛湖社区君新路164号

TELEPHONE: 0755-29673660 29673519

广东搏思远科技有限公司

Guangdong Bosyuan Technology Co., Ltd

ADDRESS: 河源市高新区富民工业园A区联体厂房A栋南栋

TELEPHONE: 0762-2820657 2820658 2820659 2820660

型号

MODEL NAME

DS-40 (6+6P)

MATERIAL PM-9823

SCALE FIT

DRWING 06/08/2021

DESIGNED 庄永委

APPROVED

产品编号

DRAWING NO

B-4042

PIN MATERIAL CP WIRE

TOLERANCE

0 < L ≤ 4	± 0.10
4 < L ≤ 16	± 0.20
16 < L ≤ 63	± 0.30
Pin径	± 0.05