

版本

A/0

REV

REVISIONS REC

DATE

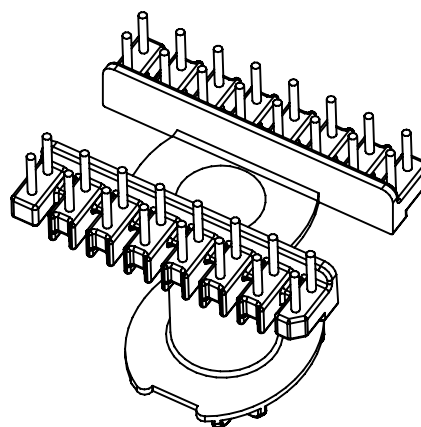
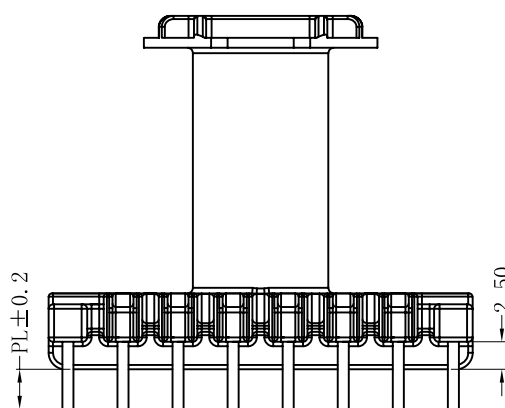
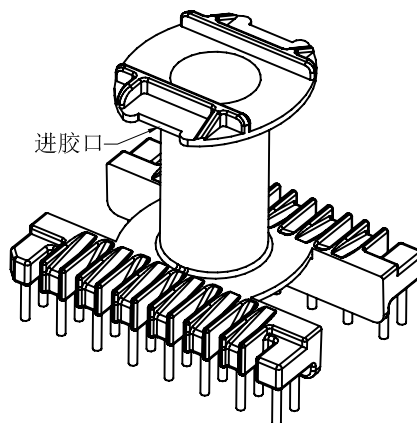
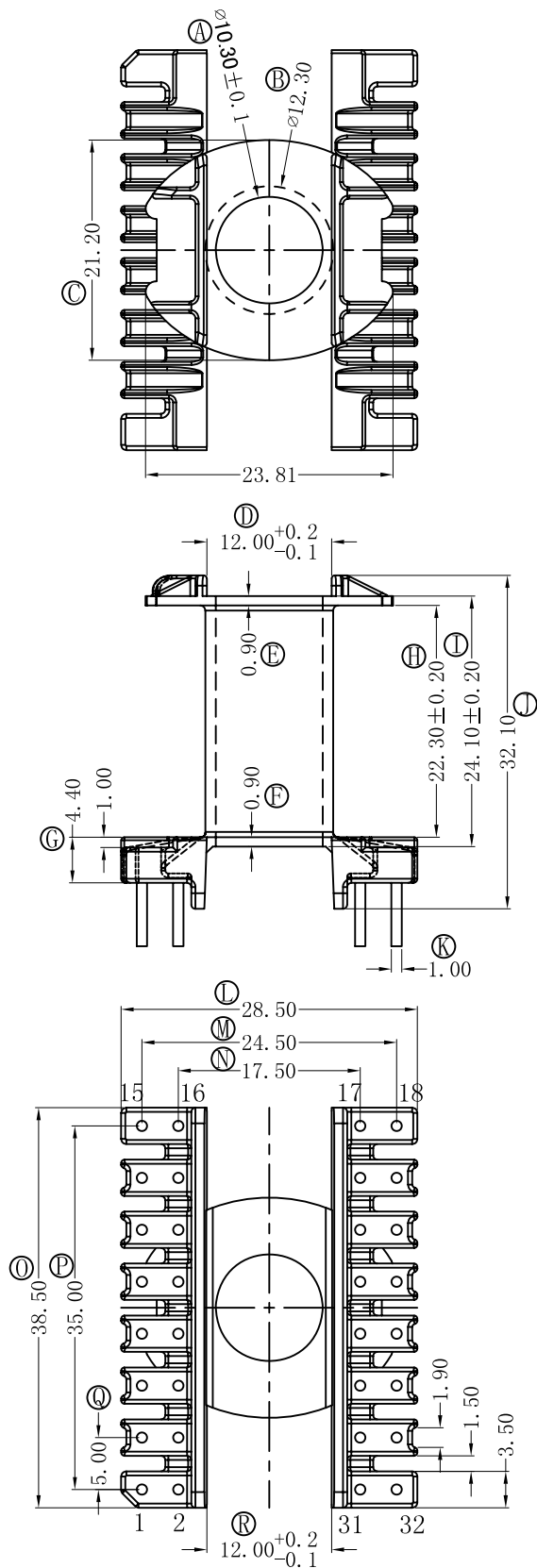

深圳市搏思康电子有限公司

SHENZHEN BOSCOM ELECTRONICS CO., LTD

ADDRESS: 深圳市龙华区观澜街道牛湖社区君新路164号

TELEPHONE: 0755-29673660 29673519

广东搏思远科技有限公司

Guangdong Bosyuan Technology Co., Ltd

ADDRESS: 河源市高新区富民工业园A区联体厂房A栋南栋

TELEPHONE: 0762-2820657 2820658 2820659 2820660

型号

MODEL NAME

ER-2834 (16+16P)

MATERIAL

PM-9820

SCALE

FIT

DRWING

27/07/2021

DESIGNED

庄永委

APPROVED

产品编号

DRAWING NO

B-28100

PIN
MATERIAL

CP WIRE

TOLERANCE

0 < L ≤ 4	± 0.10
4 < L ≤ 16	± 0.20
16 < L ≤ 63	± 0.30
Pin径	± 0.05