

版本	A/0	REV	REVISIONS REC	DATE

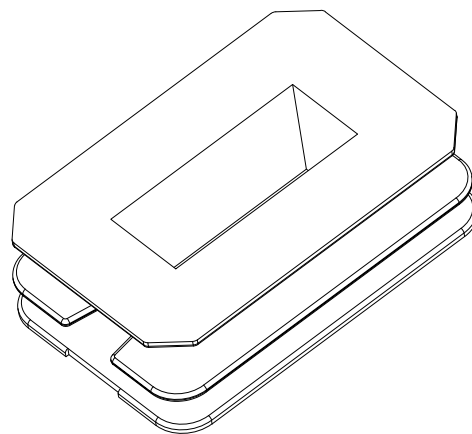
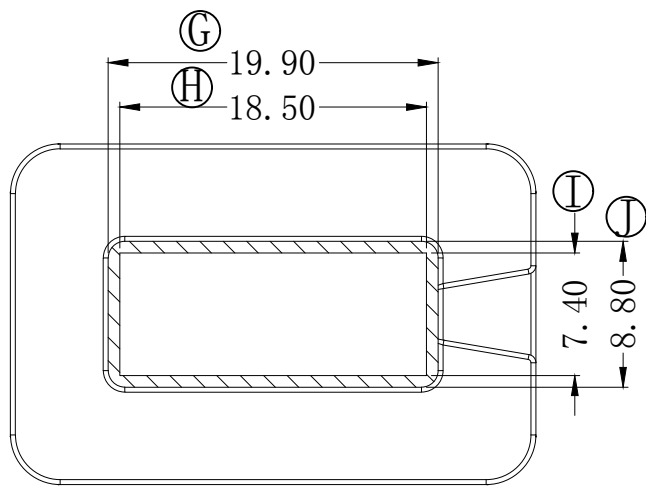
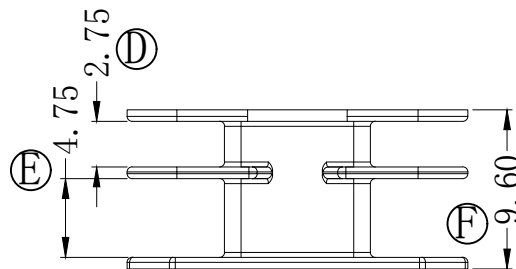
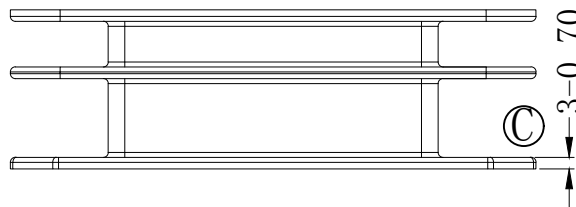
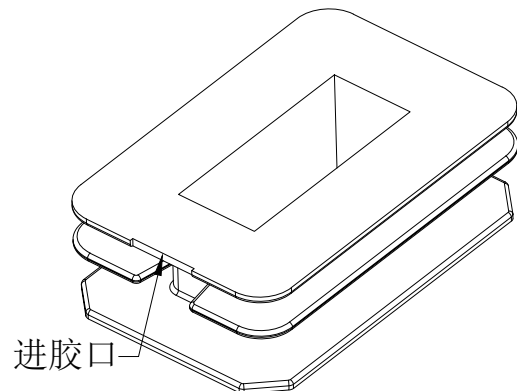
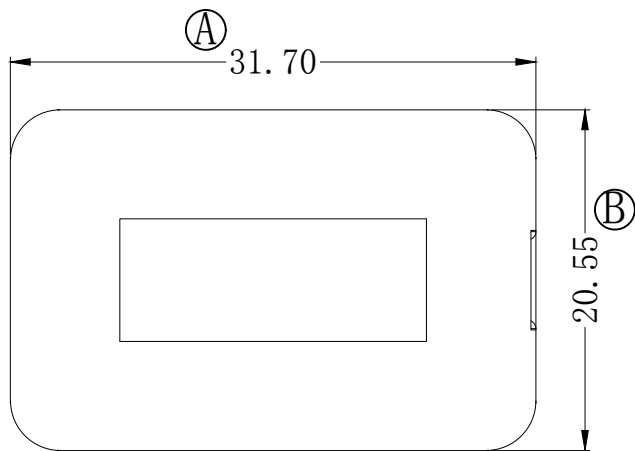

深圳市搏思康电子有限公司 SHENZHEN BOSCOM ELECTRONICS CO.,LTD ADDRESS: 深圳市龙华区观澜街道牛湖社区君新路164号 TELEPHONE: 0755-29673660 29673519		型号 MODEL NAME EE-30		产品编号 DRAWING NO B-3047-1	
广东搏思远科技有限公司 Guangdong Bosyuan Technology Co.,Ltd ADDRESS: 河源市高新区富民工业园A区联体厂房A栋南栋 TELEPHONE: 0762-2820657 2820658 2820659 2820660		MATERIAL	PM-9825	PIN MATERIAL	CP WIRE
		SCALE	FIT	TOLERANCE	
		DRWING	02/12/2022	0<L≤6	±0.10
		DESIGNED	庄永委	6<L≤30	±0.20
		APPROVED		30<L≤60	±0.30